

Features

- Includes faceplate with handle
- Single handle controls temperature setting
- Complements Artifacts faucets and accessories

Material

- Premium material construction with metal handle ensures reliability and durability
- KOHLER finishes resist corrosion and tarnishing

Installation

- Trim only; requires valve to complete installation (sold separately)
- Patented K-joint installation technology ensures consistent trim appearance, regardless of variability in valve rough-in



ADA **CSA B651** **OBC**

Codes/Standards







ASME A112.18.1/CSA B125.1
ADA
ICC/ANSI A117.1
CSA B651
OBC

KOHLER® Faucet Lifetime Limited Warranty

See website for detailed warranty information.

Available Colors/Finishes

Color tiles intended for reference only.

Color	Code	Description
	CP	Polished Chrome
	SN	Vibrant™ Polished Nickel
	BN	Vibrant™ Brushed Nickel
	BV	Vibrant™ Brushed Bronze
	2BZ	Oil-Rubbed Bronze
	2MB	Vibrant™ Brushed Moderne Brass

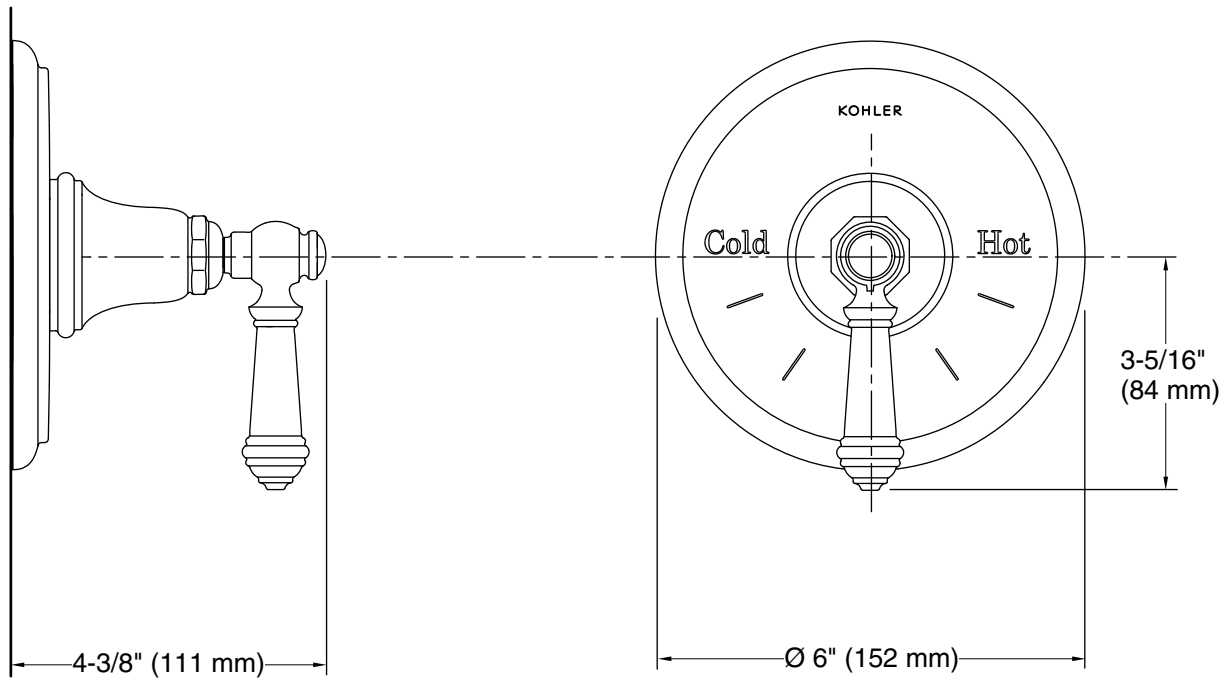

Technical Information

All product dimensions are nominal.

Notes

Install this product according to the installation instructions.

ADA, OBC, CSA B651 compliant when installed to the specific requirements of these regulations.